

도어락

DOOR LOCK

당신의 공간에 스타일을 더하다.

세련된 디자인과 부드러운 사용감을 겸비한
실내용 방문 손잡이. 디테일이 공간을 완성합니다.
소재부터 마감까지 꼼꼼하게 설계된 손잡이로,
일상 속 품격 있는 터치를 경험하세요.

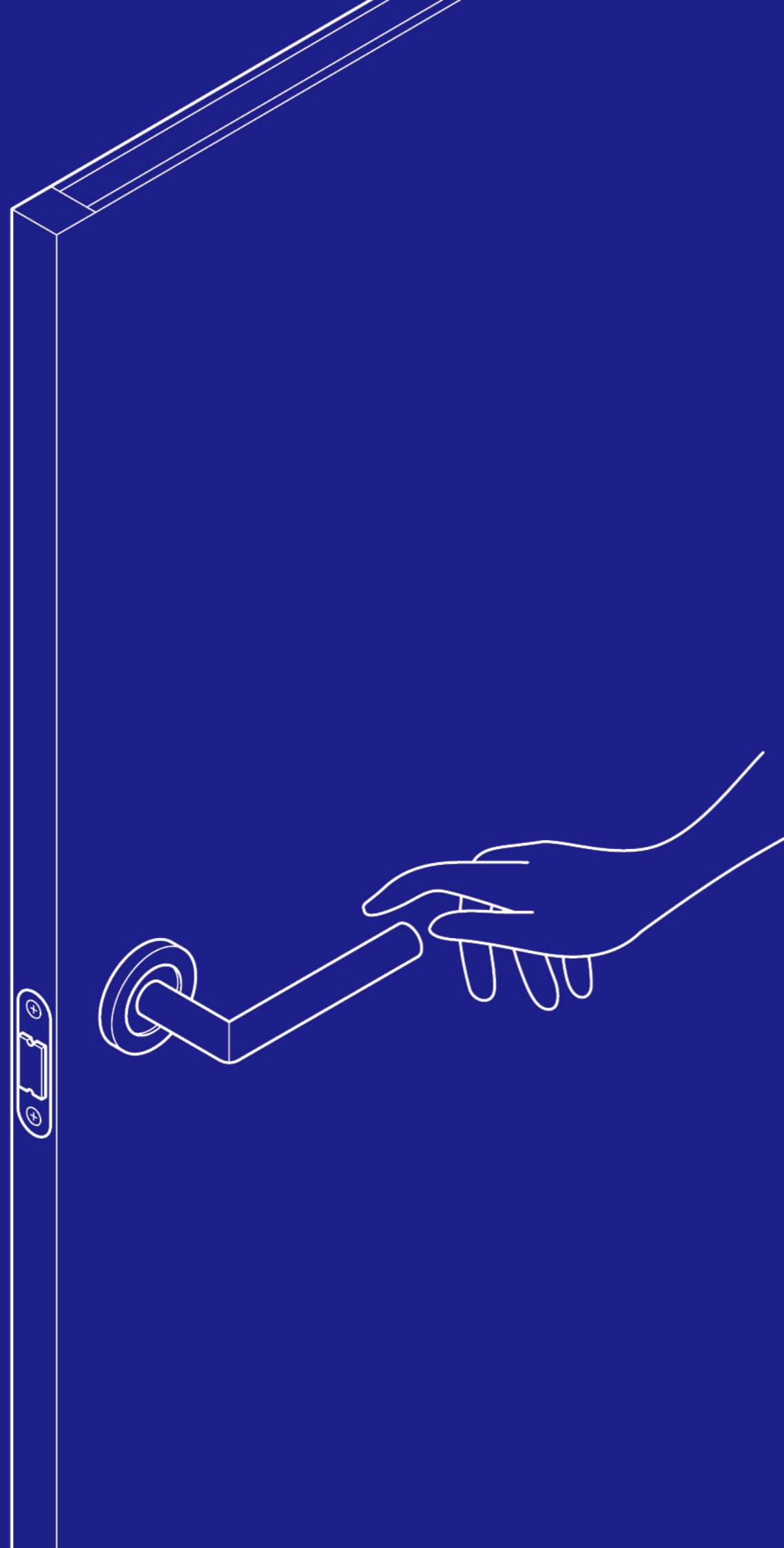



TP150 크레용3 아이보리



TP150 크레용3 옐로우



TP171 제로 화이트



TP171 제로 아이보리



TP150 크레용3 블루



P201 슬라이드 아이보리



P201 슬라이드 핑크

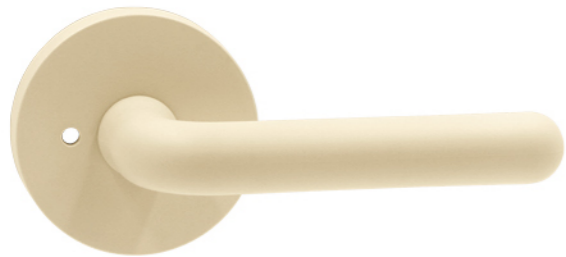

TP150 크레용 아이보리

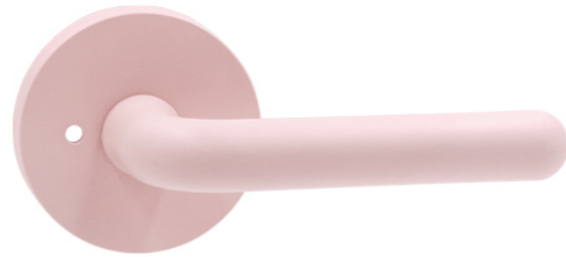

TP150 크레용 핑크



P201 슬라이드 그린



P201 슬라이드 블랙

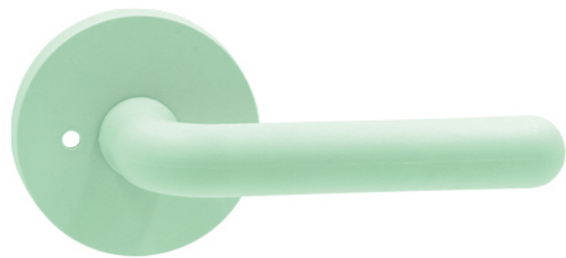

TP150 크레용 그린

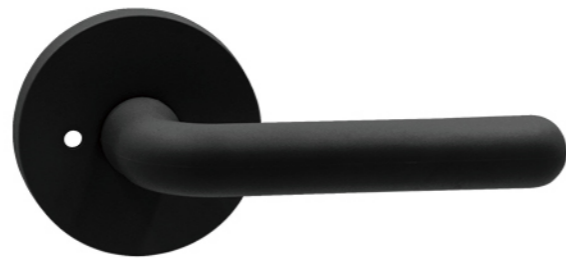

TP150 크레용 블랙



【시험 성적서】

롯데케미칼에서 생산한 안전한 소재
항균 성능을 탑재함으로써 더욱 안심하고
안전하게 사용할 수 있는 항균 솔루션



화사연혁

화사소개

하드도어

세련믹

출간소음저감
난방배관장치

손개임 방지

인공지능 기반
스마트 솔루션

도어락

산업용 기타철물



TP 101 | 돌핀 GR



TP 101 | 돌핀 EB

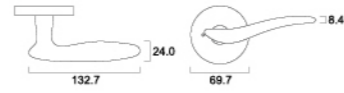

TP 178 | 갤럭시 GR

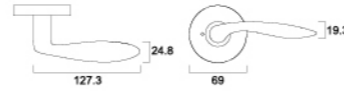

TP 165 | 볼트 GR

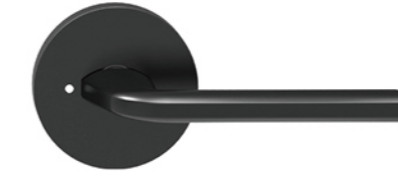

TP 165 | 볼트 BL



TP 160 | 스틱 GR



TP 178 | 갤럭시 PB/SB *피스 비노출

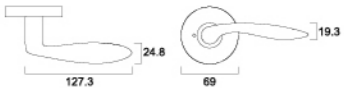

TP 109 | 샤인GR



TP 157 | 마루 GR



TP 160 | 스틱 SS 재질:SUS304

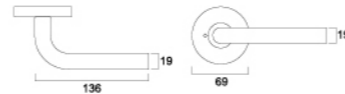

TP 160 | 스틱 BROWN



TP 160 | 스틱 BL



TP 112 | 체어맨 GR

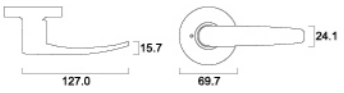

TP 147 | 모닝 GR



TP 147 | 모닝 BL



TP 172 | 라떼 WH



TP 172 | 라떼 GR



TP 172 | 라떼 BRONZE



TE 112 | 체어맨 GR



TE 147 | 모닝 GR



TE 147 | 모닝 BL



TP 172 | 라떼 DG



TP 172 | 라떼 BL



회사연혁
 회사소개
 차드도어
 세리믹
 출간순서
 나방배관장치
 손개임방치
 인공지능기반
 스마트 솔루션
 도어락
 상업용기타철물



【시험 성적서】

타공도면 Drilling Layout Drawing

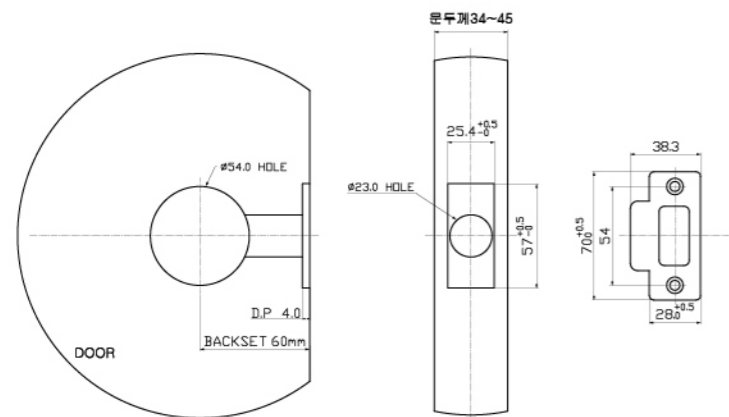

사양 Specification

- 키사양(KEY SYSTEM)
Kwikset System 5pin, MK
- 래치(LATCH)
- 래치볼트(LATCH BOLT) : 7/16" (11.0mm) AL
- 프론트(FRONT) : 57×25.4mm
- 스트라이크(STRIKE) : 70×28.0mm
- 로즈(ROSE) : Φ70mm
- 백세트(BACKSET) : 60mm
- 표면처리(FINISHES) : GRAY, GD, SN, AB
- 문두께(DOOR THICKNESS) : 35~45mm
- 포장방법(PACKING) : BOX PACK
- 기능(FUNCTION) : ENT, PAS, PRI

터치톡 락 TOUCH TOK LOCK series

공인기관의
성능평가 인증
획득

설치 방향과
상관없는
양방향 푸시풀

규격화된
래치 A'ssy
사용

쉬운 설치
다양한 디자인



원통형 CYLINDRICAL LOCK series



회사연혁
회사소개
하드웨어
세라믹
충간소음 저감
난방배관장치
손쉬운 방치
인공지능 기반
스마트 솔루션
도어락
상업용 기타 철물

방문손잡이 (튜블러) TUBULAR LOCK series

내화용 방문손잡이 FIRE-RESISTANT TUBULAR LOCK [주문제작] 방문손잡이 레버 시리즈 적용 가능

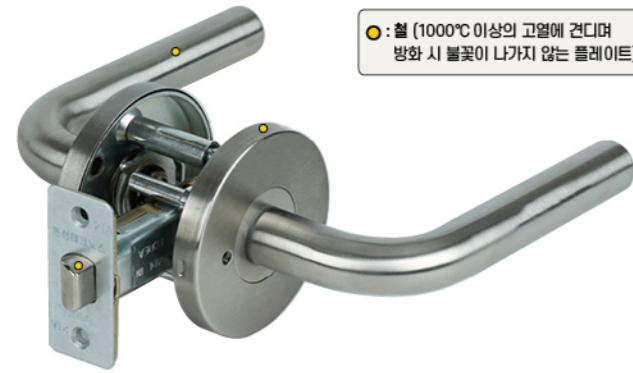

● : 철 (1000°C 이상의 고열에 견디며 방화 시 불꽃이 나가지 않는 플레이트)



【방화용 시험 성적서】 FTP

타공도면 Drilling Layout Drawing

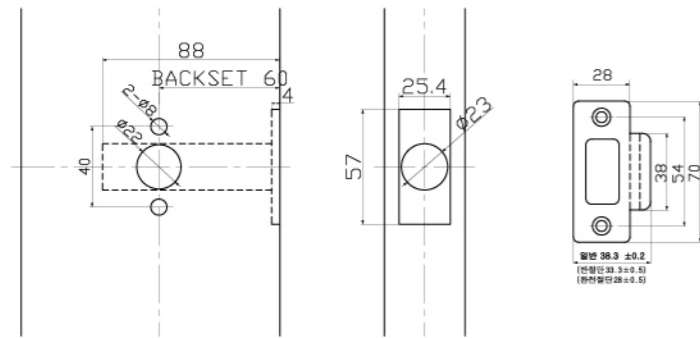

사양 Specification

- 래치(LATCH)
 - 래치볼트(LATCH BOLT) : STS(소결)
- 프론트(FRONT) : 57×25.4mm
- 스트라이크(STRIKE) : 70×28.0mm
- 백세트(BACKSET) : 60mm
- 표면처리(FINISHES) : GRAY, GD, SN, AB, AS
- 문두께(DOOR THICKNESS) : 35~45mm
- 기능(FUNCTION) : PRI

컵핸들 series

문점검구, EPS실, 기계실, 공조실 등 손잡이가 돌출되지 않는 문 설치 (BACKSET : 60mm / 재질 : SUS304)

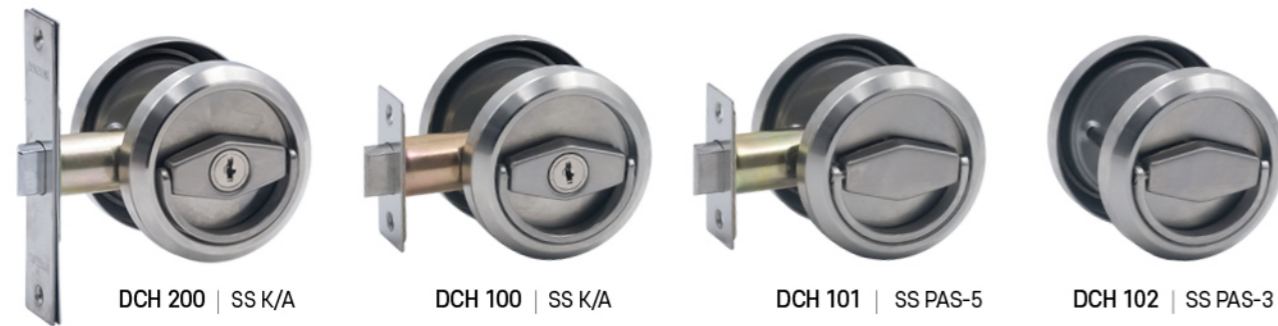

타공도면 Drilling Layout Drawing

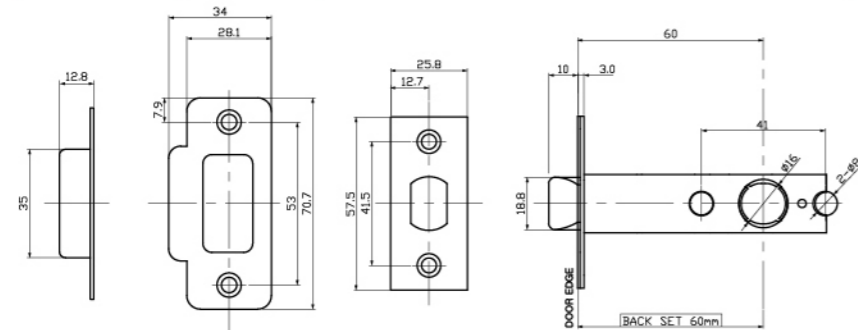

【방화용 시험 성적서】 FDCH-100SUS 일반형(허니컴)

분리형 모티스 DETACHABLE MORTISE series



제품도면 Product Drawing

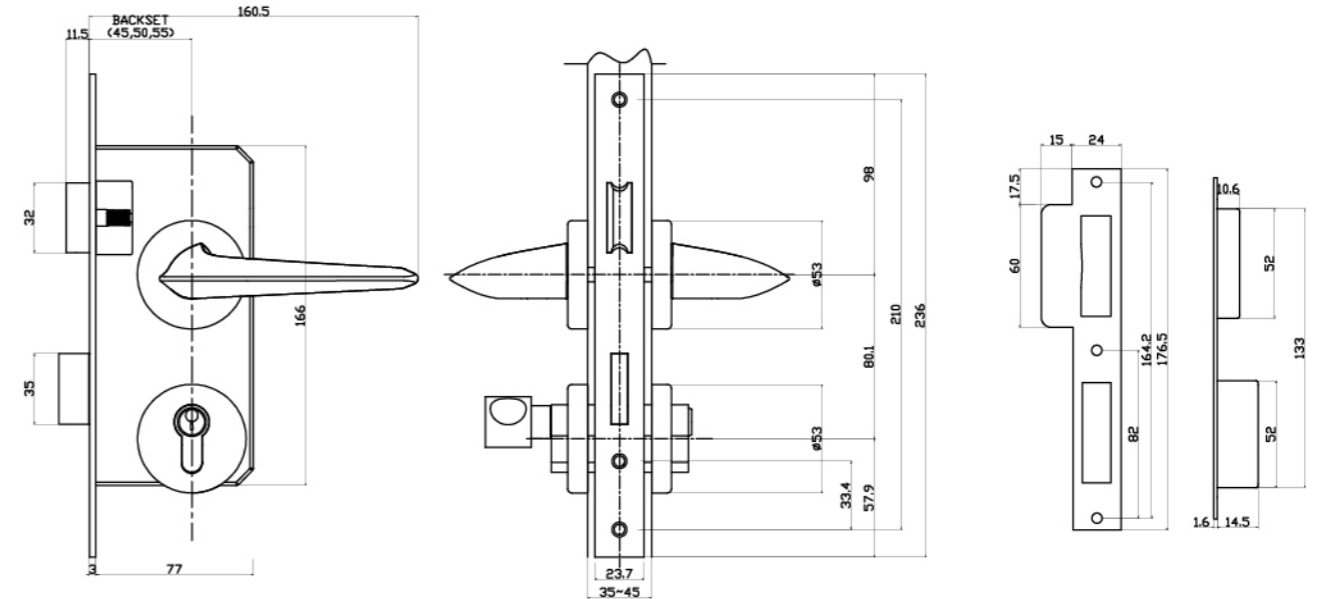

타공도면 Drilling Layout Drawing

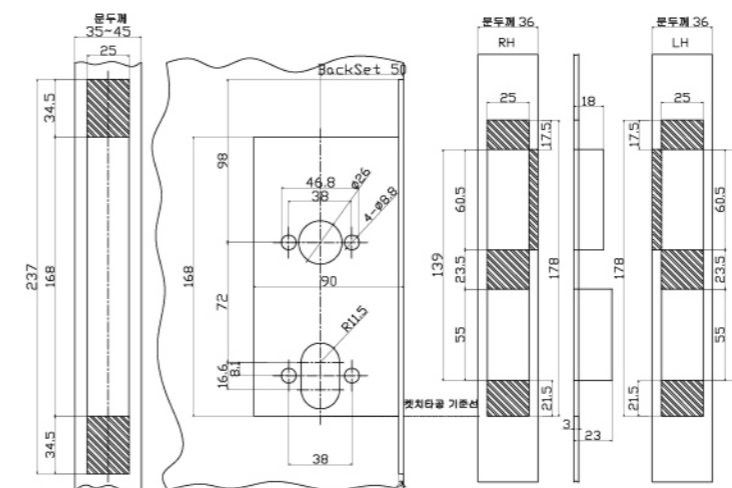

사양 Specification

- 백세트(BACKSET) : 45mm, 50mm, 55mm
- 디스텐스(DISTANCE) : 72mm
- 프론트타입(FRONT TYPE) : SQUARE
- 데드볼트(DEAD BOLT) : 1단
- 프론트피니쉬(FRONT FINISH) : SN
- 기능(FUNCTION) : ENT

회사연혁 | 회사소개 | 하도매 | 대리점 | 총간음지감 | 난방배관장치 | 손개임방치 | 인공지능기반 스마트 솔루션 | 도어락 | 상업용기타철물

9000L series



9000L | 체어맨 GR ENT



9005L | 체어맨 GR PAS-5



9003L | 체어맨 GR PAS-3



9000L | 체어맨 GR STR MK
(호탈용)

9900L series

문두께 45mm(기본), 50~80mm용 주문 제작



9900L | 체어맨 GR ENT

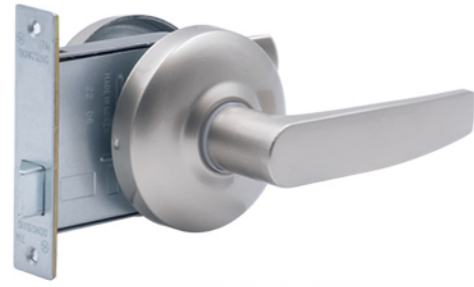

9905L | 체어맨 GR PAS-5

9000B series



9000B | SS ENT



9005B | SS PAS-5



9003B | SS PAS-3



9000B | SS STR MK
(호탈용)

9900B series

문두께 45mm(기본), 50~80mm용 주문 제작



9900B | SS ENT



9905B | SS PAS-5

타공도면 Drilling Layout Drawing

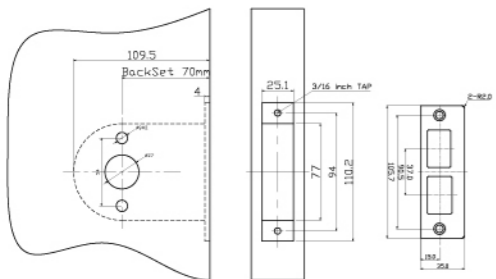

사양 Specification

- 키시스템(KEY SYSTEM) KwikSet System 6pin KD/MK/GMK
- 래치(LATCH)
 - 래치볼트(LATCH BOLT) : 1/2" (12.7mm) Steel
 - 데드볼트(DEAD BOLT) : 1" (25.4mm) Steel
- 프론트(FRONT) : 25x110mm
- 스트라이크(STRIKE) : 35x106mm
- 로즈(ROSE) : φ85mm(Lever) / φ80mm(Knob)
- 백세트(BACKSET) : 70mm
- 표면처리(FINISHES) : GRAY, GD, SB, SC, PB
- 문두께(DOOR THICKNESS) : 35~45mm
- 포장방법(PACKING) : BOX PACK



【방화용 시험 성적서】
복합형



【방화용 시험 성적서】
일반형

타공도면 Drilling Layout Drawing

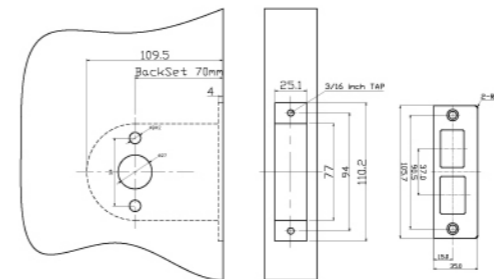

사양 Specification

- 키시스템(KEY SYSTEM) KwikSet System 6pin KD/MK/GMK
- 래치(LATCH)
 - 래치볼트(LATCH BOLT) : 1/2" (12.7mm) Steel
 - 데드볼트(DEAD BOLT) : 1" (25.4mm) Steel
- 프론트(FRONT) : 25x110mm
- 스트라이크(STRIKE) : 35x106mm
- 로즈(ROSE) : φ85mm(Lever) / φ80mm(Knob)
- 백세트(BACKSET) : 70mm
- 표면처리(FINISHES) : GRAY, GD, SB, SC, PB
- 문두께(DOOR THICKNESS) : 35~45mm
- 포장방법(PACKING) : BOX PACK



【방화용 시험 성적서】
유럽형



【방화용 시험 성적서】
일반형

회사연혁
회사소개
파트너
세리믹
충간소음저감
난방배관장치
스캐임방치
인공지능기반
스마트솔루션
도어락
상업용기타철물